

Línea Desechable

Sierra Sagital Ortopédica (Cadera/Rodilla)

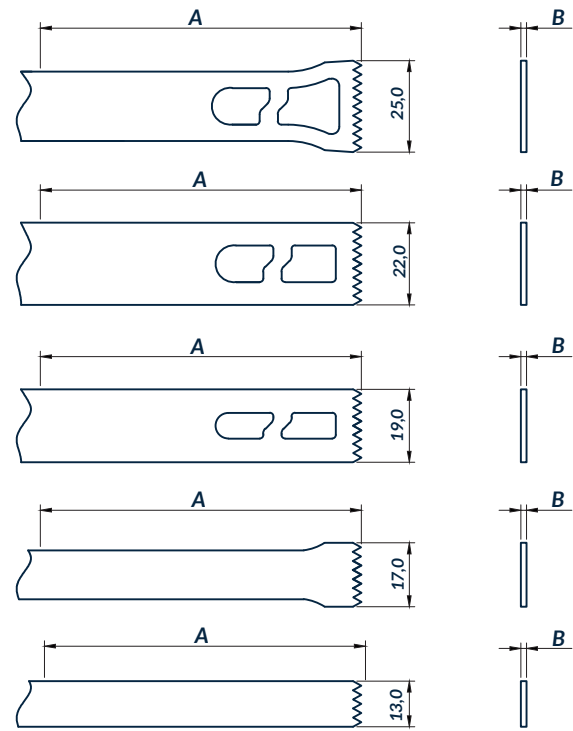

La Sierra Sagital Ortopédica se utiliza para realizar osteotomías con alta precisión y control a través de oscilaciones en dirección longitudinal.

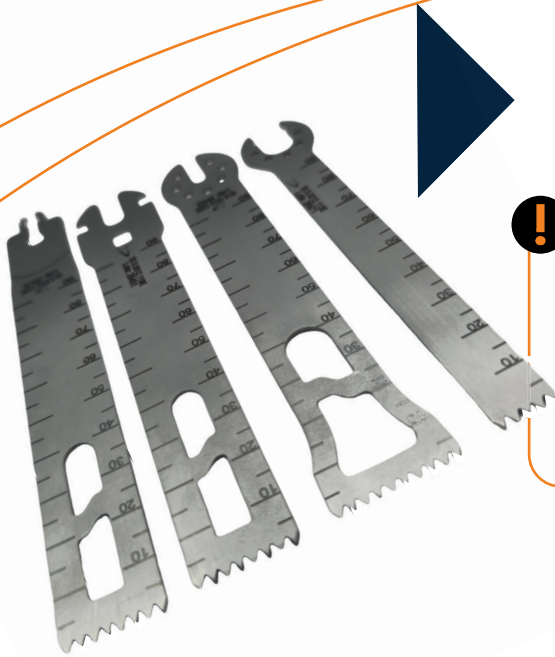

A

LONGITUD EFECTIVA

70 mm

90 mm

100 mm

B

ESPESOR

0,9 mm

1,2 mm

1,5 mm

Tipos de Acoplamiento



Información Técnica



REGISTRO ANVISA
80482499015



MATERIAL
ACERO INOXIDABLE



ESTERILIZACIÓN
ÓXIDO DE ETILENO



VALIDEZ
5 AÑOS

